



## **Elate Carbon Installation Guide**

### **Elate Carbon / Pro**

---

52, 62, 53, 63, 93, 52A,  
62A, 53A, 63A, 93A

### **Components**

---

Alto tweeter, MT450,  
MW5, MW6, MW9, MM3,  
MXT280C, MXT380C



**Dear Customer,**

Thank you for choosing Morel for your car audio speaker solution. Morel prides itself on engineering and producing the best high-fidelity speaker systems. We hope you enjoy your Elate Carbon speakers for years to come. If you have any questions, please contact your Morel dealer or Morel support at: [www.morelhifi.com](http://www.morelhifi.com)

# Elate Carbon Components

## Elate Carbon MW5, MW6, and MW9 Woofer

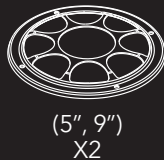
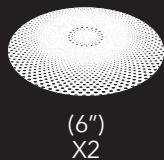
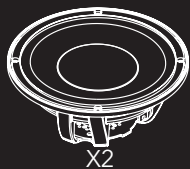

## MT450 Tweeter

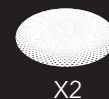

## MXT380c/MXT280c Crossover

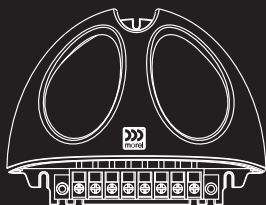

## Alto Tweeter (PRO line only)

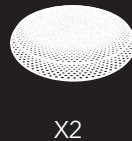

## MM3 Midrange

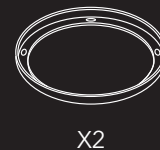

# Woofers, Midrange and Alto Tweeter mounting

## MW6 woofer

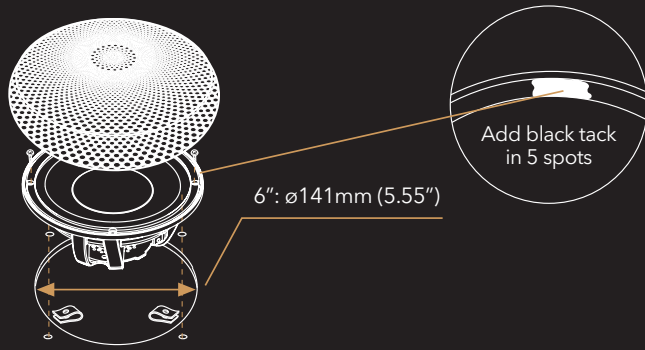

## MW5 and MW9 woofer

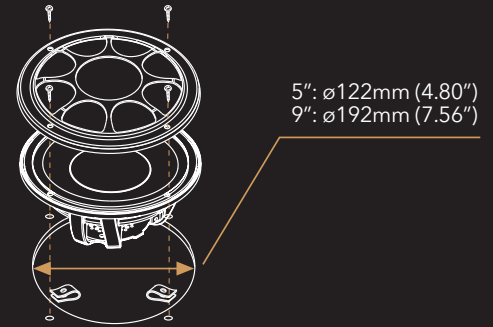

## MM3

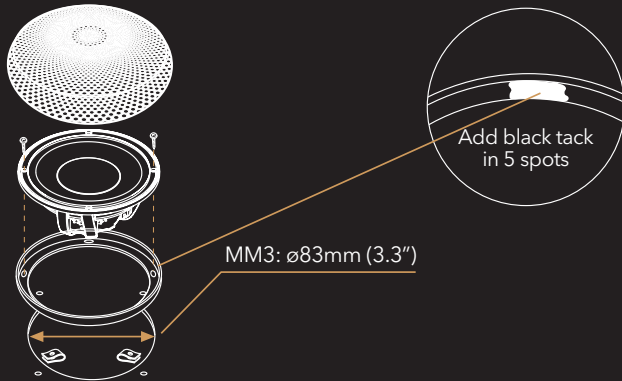

## Alto Tweeter

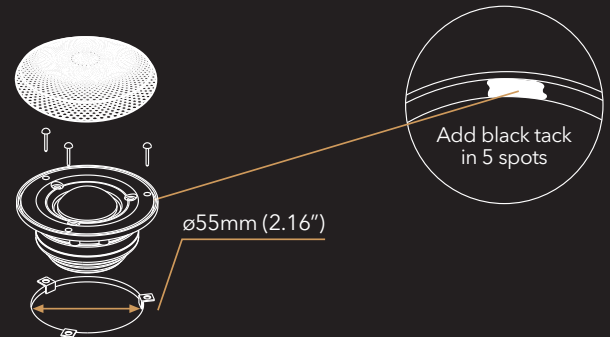

# MT450 Tweeter and Crossover Mounting

## MT450 Flush Mount

---

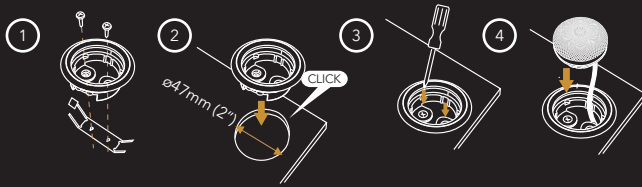

## MT450 Surface Mount

---



## Crossover mounting

---

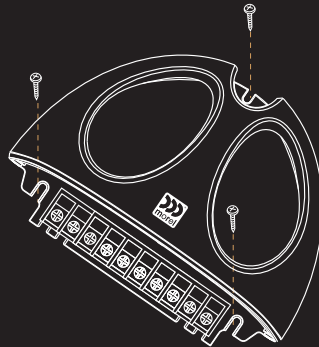

# Crossover Connections

## 2-WAY Systems Crossover

- ① Standard wire connection/  
With bridged jumpers
- ② Bi wire connection/  
No bridged jumpers
- ③ Bi Amp connection/  
No bridged jumpers

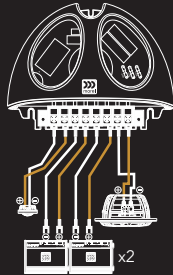
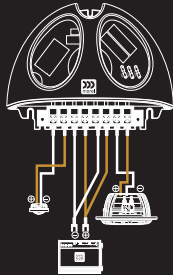
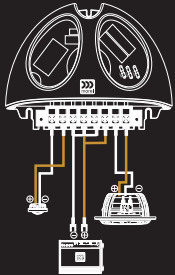

## 3-WAY Systems Crossover

- ① Standard wire connection/  
With bridged jumpers
- ② Bi wire connection/  
No bridged jumpers
- ③ Bi Amp connection/  
No bridged jumpers

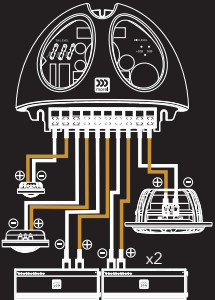
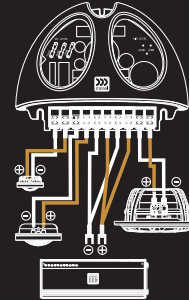
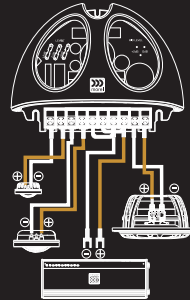

## 2-WAY Crossover Alignment System

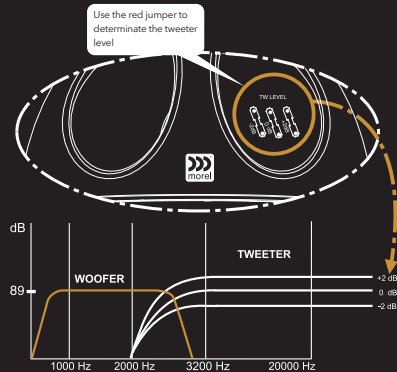

## 3-WAY Crossover Alignment System

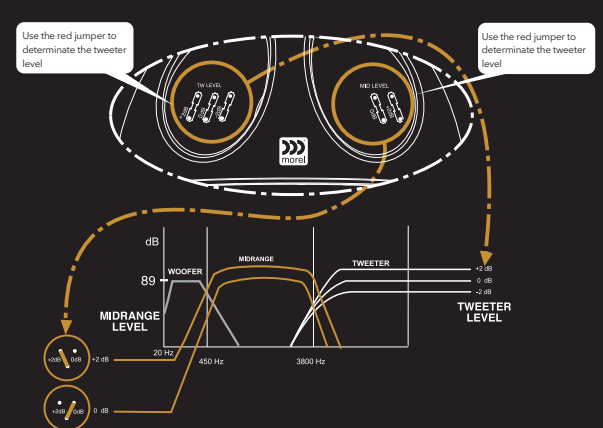

# Specifications

WOOFERS	ELATE CARBON MM3	ELATE CARBON MW5	ELATE CARBON MW6	ELATE CARBON MW9
Nominal Impedance (ohm)	4	4	4	4
Power Handling Wrms	120	160	180	200
Max. Trans. Pwr Handling Wrms	400	1000	1000	1000
Sensitivity (2.83 V/1M) dB	87	85	87	89
Frequency response Hz	90-6000	40-5000	30-4000	25-3000
Resonant Freq. Fs Hz	88	64.4	45	44
Voice Coil Diameter mm (inch)	54 (2.125)	75 (3)	75 (3)	75 (3)
Voice Coil Height mm (inch)	10 (0.4)	14.50 (0.57)	14.50 (0.57)	14.50 (0.57)
Voice Coil Type/Former	Aluminium	Titanium	Titanium	Titanium
Voice Coil Wire	Hexatech™ Aluminium	Hexatech™ Aluminium	Hexatech™ Aluminium	Hexatech™ Aluminium
DC Resistance (ohm)	3	3.6	3.6	3.6
Voice Coil Induct. @1 kHz (mH)	0.175	0.615	0.615	0.615
Magnet System	Neodymium	Neodymium	Neodymium	Neodymium Double magnet rear vented
HE-Magnetic Gap Height mm (inch)	4	5 (0.20)	5 (0.20)	5 (0.20)
B-Flux Density (T)	0.94	0.66	0.75	0.74
BL Product/BXL	4.2	5.15	6.51	5.15
Max. Linear Ex./Xmax mm (inch)	±3mm(0.12)	±4.75mm (0.18)	±4.75mm (0.18)	±4.75mm (0.18)
Suspension Compliance CMS - mm/N	0.54	0.35	0.67	0.36
Electrical Q Factor QES	0.54	0.63	0.47	0.61
QTS	0.45	0.56	0.43	0.56
QMS	2.66	4.15	7.19	6
Mech. Resistance RMS- N * S / M	1.17	1.32	1	1.2
Moving Mass MMS - gr/ounce	5.3(0.21)	17(0.59)	18(0.63)	30(1.05)
Equiv. Can Air Load VAS - L (cu.ft)	1.15(0.05)	4.5(0.6)	13.3(0.47)	30.9(1.1)
Effective Piston Area SD sq.cm (sq.inch)	38(1.5)	90(13.95)	120(18.6)	219(33.95)
Cone Type	Triple Layer Cone (TLC)	Triple Layer Cone (TLC)	Triple Layer Cone (TLC)	Triple Layer Cone (TLC)
Cone Material	Carbon Fibre composite	Carbon Fibre composite	Carbon Fibre composite	Carbon Fibre composite
Unit Diameter mm(inch)	100 (3.90)	135 (5.25)	165 (6.50)	222 (8.75)
Mounting Depth mm (inch)	38 (1.50)	60 (2.36)	61 (2.40)	71 (2.80)
Mounting Cutout	83 (3.3)	120 (4.72)	141 (5.55)	192 (7.56)
Net Wight Kg (lb)	0.38 (0.84)	1.05 (2.31)	1.18 (2.60)	1.42 (3.13)

CROSSOVERS	MXT280C	MXT380C
Crossover Point	W: 2500Hz/12dB T: 2500Hz/12dB	W: 450Hz/12dB M: 450Hz/12dB 2700Hz/12dB T: 2700Hz/12dB
Crossover Controls	Tweeter +/- 2dB	Tweeter +/- 2dB Mid 0/- 2dB
Wiring Options	Bi wire / Bi amp	Bi wire / Bi amp

\* Morel operates a policy of continuous products design improvement, consequently specifications are subject to alteration without prior notice

MIDS & TWEETERS	MT450	ALTO
Nominal Impedance (ohm)	6	6
Power Handling Wrms	130	220
Max. Trans. Pwr Handling Wrms (10ms)	350	1000
Sensitivity (2.83 V/1M) dB	91	91
Frequency Response Hz	1400-25000	1400-25000
FS Hz	1000	900
Voice Coil Diameter mm (inch)	28 (1.125)	28 (1.125)
Voice Coil Former	Aluminium	Aluminium
Voice Coil Wire	Hexatech™ Aluminium	Hexatech™ aluminium
DC Resistance ohm	5.2	5.2
Magnet System	Neodymium Rear Vented	Neodymium rear chamber underhung
Dome Type	Acuflex™ hand coated soft dome	Acuflex™ hand coated soft dome
Dome Material	Silk	Silk
Unit Diameter mm (inch)	43.00 (1.69)	67.00 (2.6)
Mounting Depth mm (inch)	13.2 (0.52)	32.00 (1.25)
Mounting Cutout mm (inch)	47.00 (2)	55 (2.16)
Net Weight Kg (lb)	0.07 (0.15)	0.35 (0.77)

## Active Configuration

Setting up the Elate Carbon system using an external electronic crossover network may very depending on the processor itself, the car cabin acoustic attributes, and the mounting location of the drive units. Choosing proper crossover points and slopes can greatly affect system performance.

The following guidelines should be used to assure each drive unit in the system performs to the highest level. The Optimal Crossover Point/Slope guide should be used for most vehicle applications. Advanced users may refer to the Recommended Crossover Range/Minimum Slope guide for fine system tuning.

### Elate Carbon: 53A, 63A, 93A

**Optimal Crossover Point/Slope**  
Tweeter highpass: 3300Hz/12dB  
Midrange lowpass: 3300Hz/12dB  
Midrange highpass: 450Hz/12dB  
Woofer lowpass: 450Hz/12dB  
\* Woofer highpass: 40Hz/12dB

**Recommended Crossover Range/Minimum Slope**  
Tweeter highpass: 18000Hz-4000Hz/12dB  
Midrange lowpass: 18000Hz-4000Hz/6dB  
Midrange highpass: 300Hz-750Hz/12dB  
Woofer lowpass: 350Hz-750Hz/6dB  
\* Woofer highpass: 40Hz-80Hz/12dB

\* When used with an active subwoofer system.

### Elate Carbon: 52A, 62A, 92A

**Optimal Crossover Point/Slope**  
Tweeter highpass: 2000Hz/12dB  
Woofer lowpass: 1800Hz/12dB  
\* Woofer highpass: 60Hz/12dB

**Recommended Crossover Range/Minimum Slope**  
Tweeter highpass: 18000Hz-3000Hz/12dB  
Woofer lowpass: 18000Hz-3000Hz/6dB  
\* Woofer highpass: 40Hz-80Hz/12dB

**Wishing you many years of sound enjoyment!**



Morel, Ness Ziona, 70400 Israel.  
Tel: +972-8-9301161  
Fax: +972-8-9301312  
E-mail: [info@morelhifi.com](mailto:info@morelhifi.com)

Morel America, Chandler, AZ, USA  
Toll free number: 1-877-667-3511  
Fax: 1-718-721-1560  
E-mail: [info@morelamerica.com](mailto:info@morelamerica.com)

[www.morelhifi.com](http://www.morelhifi.com)