

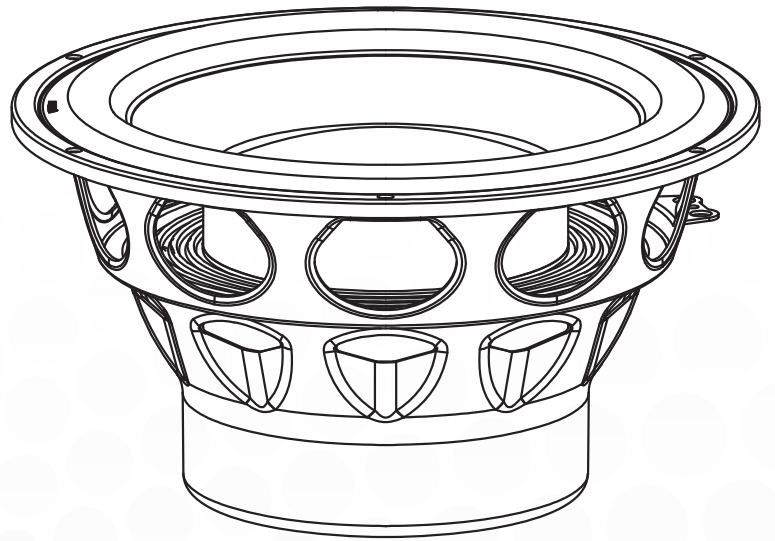

ULTIMO SUBWOOFERS SERIES

Ultimo Titanium

Ultimo Titanium SC

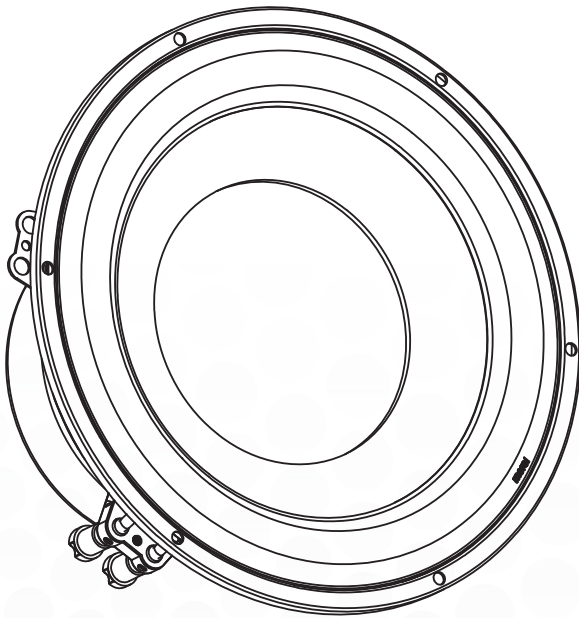

USER MANUAL

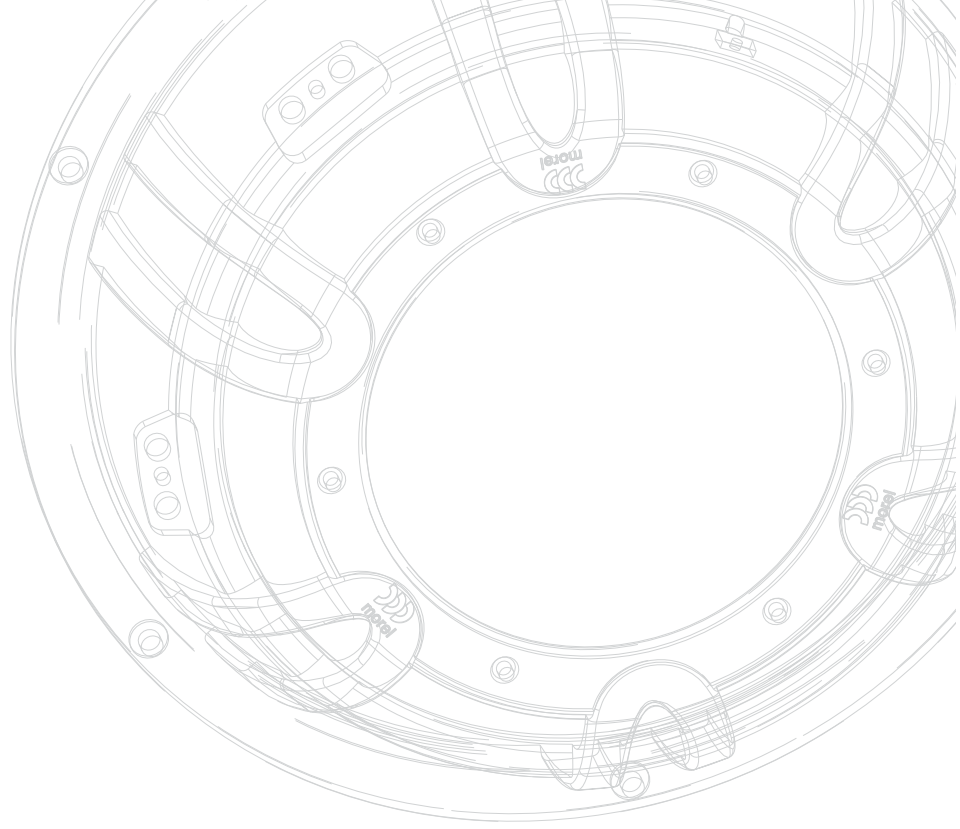

Introduction

Dear customer,

Thank you for choosing Morel's Ultimo Titanium subwoofer to satisfy your demanding car audio standards. The award winning Ultimo series was engineered with a combination of tight, controlled musicality and life-like deep bass reproduction.

Consistent with Morel's philosophy, this handcrafted subwoofer will satisfy those who like to "crank it up". The Ultimo represents an extraordinary combination of audiophile bass quality, high power handling and ease of installation.



Technology features

Morel's Ultimo is the ultimate in subwoofer technological innovation and performance. Designed to perform well in sealed or ported enclosures, the Ultimo's gigantic 5.1" (130mm) Hexatech™ voice coil delivers powerful, accurate, dynamic, and musical bass notes.

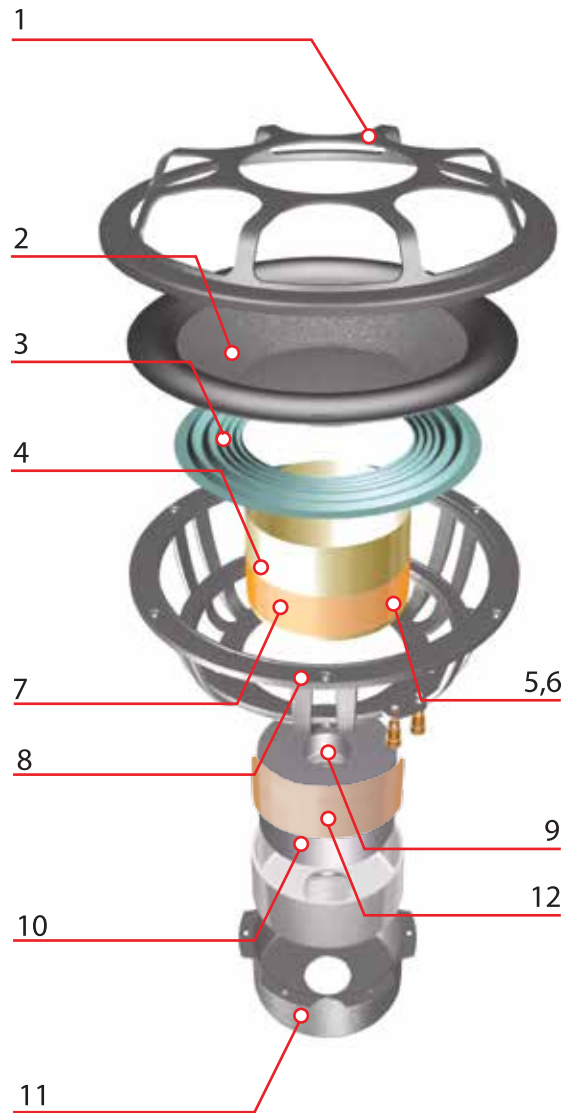

1. Octopus Grille

Innovative design to provide protection and maintain acoustics transparency.

2. One piece Hybrid Cone

An integrated cone made from a composite of paper and carbon fiber for improved musicality. High power handling and low distortion.

3. PFS™

Progression Field Symmetry engineering for longer linear excursion and optimized performance at high power output.

4. Titanium Voice Coil Former

Rigid and lightweight it provides a tonally balanced and accurate driver, with exceptionally fast transient response.

5. External Voice Coil

A gigantic 5.1" (130mm) voice coil for improved cone support high mechanical and thermal power handling.

6. Accucenter™

Self-centering engineering for easy voice coil repair.

7. Hexatech™ Aluminum Voice Coil

For minimal loss of magnetic flux and low induction for improved efficiency.

8. Uniflow™

An aluminum die-cast chassis to eliminate unwanted vibration noise and for increased durability.

9. Cooling Duct

Enables air cooling circulation for thermally stable operation of the voice coil.

10. DMM™

Optimized and compact Double Magnet Motor that achieves 90% efficiency.

11. Magnet Cup Enclosure

Heavy-duty enclosure, engineered to attach to the Uniflow chassis, enable quick and easy replacement of the magnet motor and cone coil assembly if necessary.

12. Copper Sleeve Shorting Ring

Reduces voice coil inductance and total harmonic distortion, for an improved amplifier performance.

Choosing the correct enclosure

Enclosure selection depends both on the environment and on the desired performance. The power input and size of the vehicle play an important role in correctly installing the subwoofer, as does the preferred bass experience.

The Ultimo Titanium series subwoofers are designed to work optimally in both ported and sealed enclosures however, each of these enclosure types will produce a slightly different sounding result.

As a rule of thumb, the bigger the enclosure, the lower the bass frequency response will be but it will have less control and definition. On the contrary, as the enclosure volume gets smaller, the bass frequency response is higher, but the bass reproduction is faster and tighter. For those of you who are looking to get optimal SQ results, we highly suggest using sealed enclosures; for those who are seeking high SPL, we suggest using ported enclosures. The table below specifies the required volume range needed for the Ultimo Titanium series to produce best results in both sealed and ported enclosures.

ported (Bass reflex) enclosures

Ported enclosures have a circular or rectangular tube or duct leading to an opening in the enclosure structure. If tuned properly, a ported enclosure enables greater bass extension from a smaller enclosure, as well as better power handling, efficiency, control and faster bass reproduction.

Sealed enclosures

These completely sealed enclosures are not affected by air pressure changes inside the enclosure due to cone movement. Acoustic suspension and cone movement linearity are improved, resulting in lower distortion and higher power levels. The drawbacks of the sealed enclosures are lower efficiency due to powerful absorption inside the enclosure, and reduced transient response at lower frequencies. In conclusion, sealed enclosures provide powerful bass reproduction and excellent dynamics with extremely low distortion.

Morel's recommended enclosure volumes for ported and sealed enclosures

	ULTIMO TITANIUM 8	ULTIMO TITANIUM 10	ULTIMO TITANIUM 12
Ported Enclosure	10- 30lit (0.353-0.529 cu.ft) Optimal performance at 10 lit (0.353 cu.ft)	15-50 lit (0.635-1.412 cu.ft) Optimal performance at 30 lit (1.059 cu.ft)	20-80 lit (0.882-2.11 cu.ft) Optimal performance at 45 lit (1.589 cu.ft)
Sealed enclosure	6.5- 40lit (0.022- 1.4cu.ft)	12- 50lit (0.423-1.76 cu.ft)	20-60 lit (0.706-2.11 cu.ft)

	ULTIMO TITANIUM SC 10	ULTIMO TITANIUM SC 12
Ported Enclosure	19-40 lit (0.67-1.412 cu ft) Optimal performance at 29 lit (1.024 cu.ft)	30-60 lit (1.059-2.11 cu.ft) Optimal performance at 45 lit (1.58 cu.ft)
Sealed enclosure	13-30 lit (0.459-1.059 cu.ft)	20-50 lit (0.706-1.76 cu.ft)

The following graphs simulate the Ultimo Titanium and Ultimo Titanium SC subwoofers optimal performance in ported and sealed enclosures. These guidelines will enable you to choose the best option suited for you. Please note: the recommended enclosure sizes specified include driver displacement.

Ported & sealed enclosure graphs

ULTIMO TITANIUM 8"

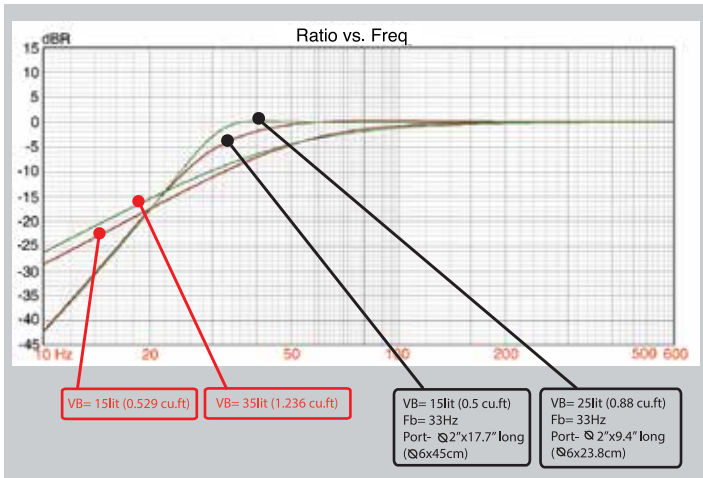

ULTIMO TITANIUM 10"

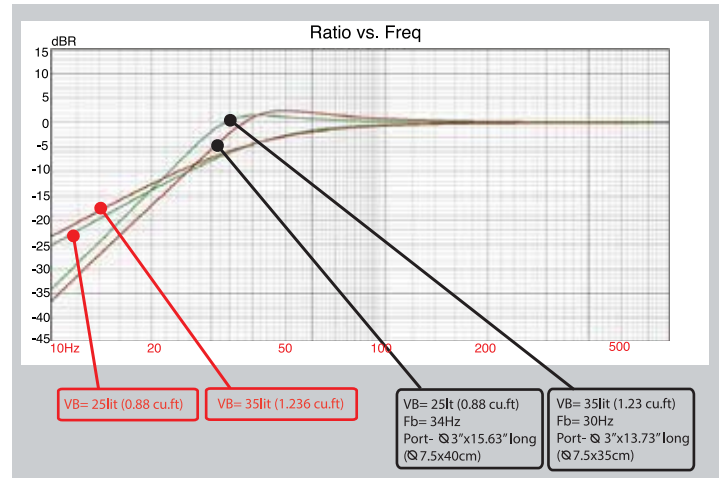

ULTIMO TITANIUM 12"

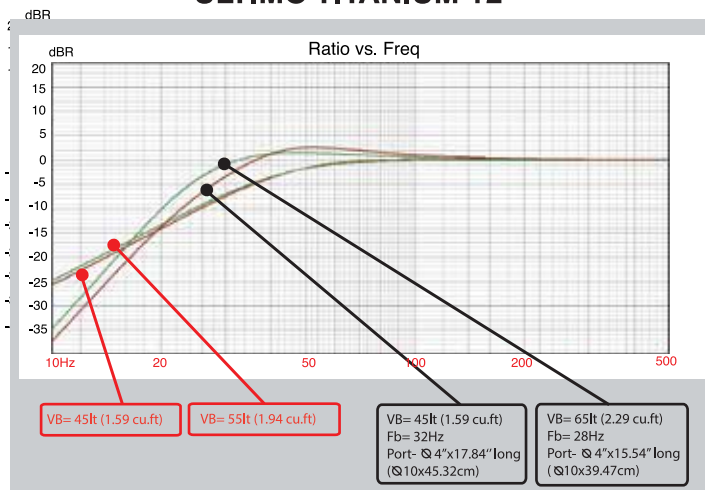

ULTIMO TITANIUM SC 10"

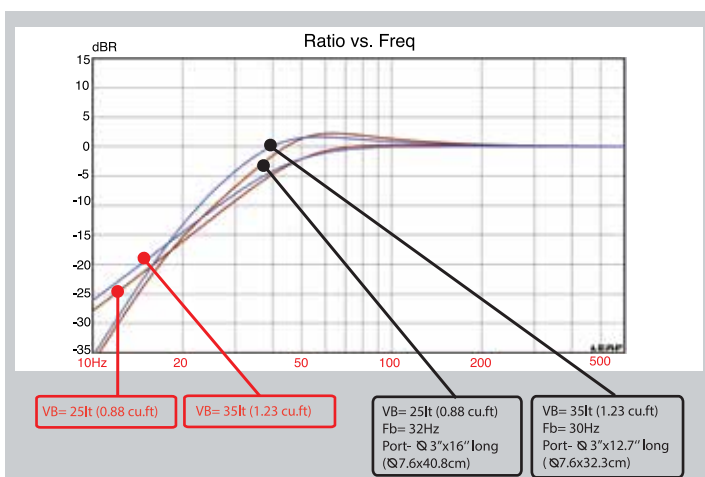

ULTIMO TITANIUM SC 12"

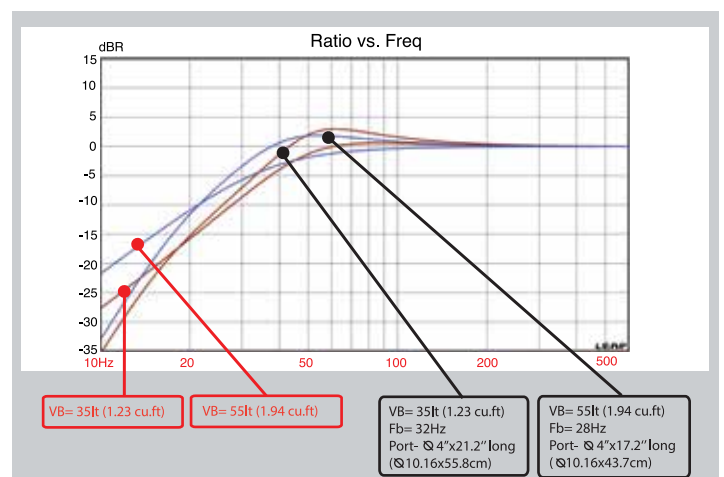

Connecting the Ultimo Titanium subwoofer

The Ultimo Ti subwoofers may be connected to your amplifier in a variety of configurations, as suggested below.

Series connection (1–3 woofers)

Ultimo 2 ohm version

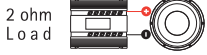

Ultimo 4 ohm version



Parallel connection (2–4 woofers)

Ultimo 2 ohm version

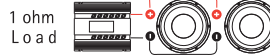

Ultimo 4 ohm version

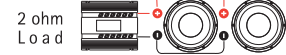

Tuning recommendation

Once the proper enclosure has been constructed, please follow these tips to optimize the performance of your new Ultimo subwoofer. It is always suggested to consult your Authorized Morel Dealer for more specific guidance, if necessary.

1. Set your gain level control to ensure stable amplifier operation without distortion or saturation to prevent subwoofer damage.
2. Adjust the cut-off frequency according to the enclosure design and subwoofer specifications to ensure optimal performance.
3. Electronic acoustic corrective filters (e.g. equalizer) are not required, as long as the subwoofer enclosure is designed properly.
4. After listening to the subwoofer you may choose to invert the phase. Doing so will affect the acoustic performance of the subwoofer. It is recommended to listen in both configurations in order to determine your preferred mode.
5. Before adjusting your sound system further, it is suggested to move the subwoofer enclosure to different locations in the car trunk. Placing the enclosure in different locations may provide the solution you seek.

Cone replacement procedure

The Ultimo Titanium subwoofer was designed using Morel's Trademark Accucenter™ technology, which enable easy, quick replacement of a damaged voice coil cone assembly by simply dismantling the magnet motor system and bolting it to a new chassis and cone assembly. Please carefully follow the instructions below.

1.



2.

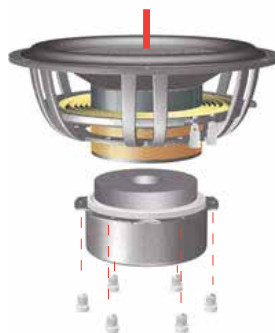

3.

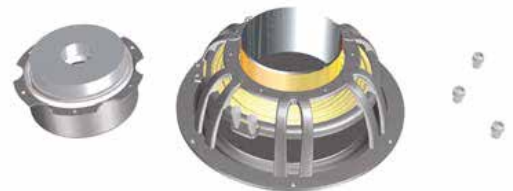

4.

Cleaning the magnet gap:
Fold masking tape - sticky side out, insert into the gap and swirl around.



5.

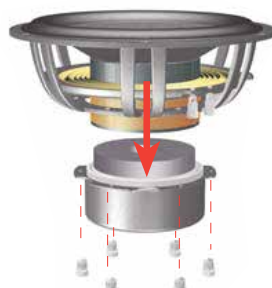

6.



Ultimo Titanium Specifications

General data		ULTIMO TITANIUM 8		ULTIMO TITANIUM 10		ULTIMO TITANIUM 12	
		2 ohm	4 ohm	2 ohm	4 ohm	2 ohm	4 ohm
Overall Dimensions	DxH	∅ 222mm (8.74") X 120mm (4.72")	∅ 263mm (10.35") X 120mm (4.72")	∅ 263mm (10.35") X 140.3mm (5.52")	∅ 305mm (12") X 146.9mm (5.78")	∅ 305mm (12") X 146.9mm (5.78")	∅ 305mm (12") X 146.9mm (5.78")
Power Handling RMS	P	800 W	1000 W	1000 W	1000 W	1000 W	1000 W
Transient power 10ms		3000 W	3000 W	3000 W	3000 W	3000 W	3000 W
Sensitivity 2.83Vrms/1M		84 dB	83.7dB	86.1dB	85 dB	87 dB	86.3 dB
Sensitivity 1W/1M		83.5 dB	83.5 dB	84.5 dB	84.5 dB	85 dB	85 dB
Frequency Response		20-900 Hz	20-900 Hz	10-900 Hz	10-900 Hz	10-900 Hz	10-900 Hz
Cone Material		Carbon-fiber laminated paper	Carbon-fiber laminated paper	Carbon-fiber laminated paper	Carbon-fiber laminated paper	Carbon-fiber laminated paper	Carbon-fiber laminated paper
Net Weight		6.1 Kg. (13.44 lb)	6.1 Kg. (13.44 lb)	6.5 Kg. (14.3 lb)	6.5 Kg. (14.3 lb)	6.7 Kg. (15 lb)	6.7 Kg. (15 lb)
Driver displacement		2.0 Lit (0.07 cu.ft)	2.0 Lit (0.07 cu.ft)	2.34 Lit (0.08 cu.ft)	2.34 Lit (0.08 cu.ft)	2.6 Lit (0.09 cu.ft)	2.6 Lit (0.09 cu.ft)
Voice Coil and Magnet Parameters -with 5 inch copper sleeve							
Voice Coil Diameter		130 mm (5.1")	130 mm (5.1")	130 mm (5.1")	130 mm (5.1")	130 mm (5.1")	130 mm (5.1")
Voice Coil Height		37mm (1.45")	37mm (1.45")	37mm (1.45")	37mm (1.45")	37mm (1.45")	37mm (1.45")
Voice Coil Former		Titanium	Titanium	Titanium	Titanium	Titanium	Titanium
Voice coil wire		Hexatech Aluminum	Hexatech Aluminum	Hexatech Aluminum	Hexatech Aluminum	Hexatech Aluminum	Hexatech Aluminum
Number of layers		2	2	2	2	2	2
Max. Linear excursion	X	± 12.5 mm (0.5") (Each way)	± 12.5 mm (0.5") (Each way)	± 12.5 mm (0.5") (Each way)	± 12.5 mm (0.5") (Each way)	± 12.5 mm (0.5") (Each way)	± 12.5 mm (0.5") (Each way)
Magnet system type		Double magnet vented	Double magnet vented	Double magnet vented	Double magnet vented	Double magnet vented	Double magnet vented
HE-Magnetic gap height	HE	12mm (0.5")	12mm (0.5")	12mm (0.5")	12mm (0.5")	12mm (0.5")	12mm (0.5")
B flux density	B	0.64 T	0.64 T	0.64 T	0.64 T	0.64 T	0.64 T
BL product	BXL	13.0 T·M	13.0 T·M	13.0 T·M	13.0 T·M	13.0 T·M	13.0 T·M
Electrical Data							
Nominal Impedance	Z	2.0 ohm	4.0 ohm	2.0 ohm	4.0 ohm	2.0 ohm	4.0 ohm
DC Resistance	RE	1.7 ohm	3.7 ohm	1.7 ohm	3.7 ohm	1.7 ohm	3.7 ohm
Voice Coil Inductance @ 1KHz	LBM	0.14mH	0.44mH	0.14mH	0.44mH	0.14mH	0.44mH
T-S Parameters							
Suspension Compliance	CMS	0.19 $\frac{m}{N}$	0.17 $\frac{m}{N}$	0.36 $\frac{m}{N}$	0.46 $\frac{m}{N}$	0.37 $\frac{m}{N}$	0.33 $\frac{m}{N}$
Mechanical Q Factor	QMS	3.88	4.31	4.34	4.37	5.09	6.53
Electrical Q Factor	QES	0.73	0.61	0.58	0.41	0.61	0.50
Total Q Factor	QTS	0.62	0.53	0.51	0.37	0.54	0.46
Mechanical Resistance	RMS	5.49 $\frac{N}{m}$	5.26 $\frac{N}{m}$	4.26 $\frac{N}{m}$	3.37 $\frac{N}{m}$	3.42 $\frac{N}{m}$	2.94 $\frac{N}{m}$
Moving Mass	MMS	107g	107g	127g	127g	134g	134g
Resonant Frequency	FS	39Hz	39Hz	Hz	Hz	24 Hz	24 Hz
Eq. Cas Air Load (liters)	VAS	17 Lit (0.6 cu.ft)	16 Lit (0.56cu.ft)	66 Lit (2.33cu.ft)	85 Lit (3.02cu.ft)	117 Lit(4.12cu.ft)	103 Lit(3.63cu.ft)
Effective Piston Area	SD	0.0254 m ²	0.0254 m ²	0.0363 m ²	0.0363 m ²	0.0471 m ²	0.0471 m ²

Overall Dimensions

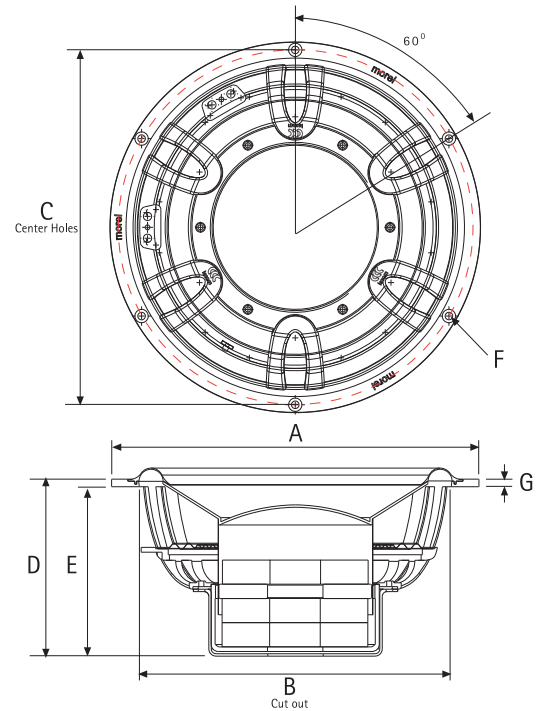

	ULTIMO TITANIUM 8	ULTIMO TITANIUM 10	ULTIMO TITANIUM 12
A	∅ 8.74" (222mm)	∅10.35" (263mm)	∅12" (305mm)
B	∅ 7.87" (200mm)	∅9.13" (232mm)	∅10.62" (270mm)
C	∅ 8.38" (213mm)	∅9.96" (253mm)	∅11.496" (292mm)
D	4.68" (119mm)	5.52" (140.3mm)	5.78" (146.9mm)
E	4.48" (114mm)	5.27" (134mm)	5.53" (140.69mm)
F	∅ 0.188" (4.8mm)	∅0.244" (6.2mm)	∅0.244" (6.2mm)
G	∅ 0.19" (5mm)	∅0.25" (6.3mm)	∅0.25" (6.3mm)

Ultimo Titanium SC Specifications

General data		ULTIMO TITANIUM SC 10		ULTIMO TITANIUM SC 12	
		2 ohm	4 ohm	2 ohm	4 ohm
Overall Dimensions	DxH	∅ 263mm (10.35") X 143mm (5.63")	∅ 263mm (10.35") X 143mm (5.63")	∅ 305mm (12") X 151.5mm (5.96")	∅ 305mm (12") X 151.5mm (5.96")
Power Handling RMS	P	600 W	600 W	600 W	600 W
Transient power 10ms		2000 W	2000 W	2000 W	2000 W
Sensitivity 2.83Vrms/1M		86 dB	86 dB	87 dB	87dB
Frequency Response		10-900 Hz	10-900 Hz	10-900 Hz	10-900 Hz
Cone Material		Carbon-fiber laminated paper	Carbon-fiber laminated paper	Carbon-fiber laminated paper	Carbon-fiber laminated paper
Net Weight		6.1 Kg. (13.44 lb)	6.1 Kg. (13.44 lb)	6.2 Kg. (13.66 lb)	6.2 Kg. (13.66 lb)
Driver displacement		2.34 Lit (0.08 cu.ft)	2.34 Lit (0.08 cu.ft)	2.6 Lit (0.09 cu.ft)	2.6 Lit (0.09 cu.ft)
Voice Coil and Magnet Parameters					
Voice Coil Diameter		130 mm (5.1")	130 mm (5.1")	130 mm (5.1")	130 mm (5.1")
Voice Coil Height		31mm (1.2")	31mm (1.2")	31mm (1.2")	31mm (1.2")
Voice Coil Former		Titanium	Titanium	Titanium	Titanium
Voice coil wire		Hexatech Aluminum	Hexatech Aluminum	Hexatech Aluminum	Hexatech Aluminum
Number of layers		2	2	2	2
Max. Linear excursion	X	± 9.5 mm (0.37") (Each way)	± 9.5 mm (0.37") (Each way)	± 9.5 mm (0.37") (Each way)	± 9.5 mm (0.37") (Each way)
Magnet system type		Double magnet vented	Double magnet vented	Double magnet vented	Double magnet vented
HE-Magnetic gap height	HE	12mm (0.47")	12mm (0.47")	12mm (0.47")	12mm (0.47")
B flux density	B	0.64 T	0.64 T	0.64 T	0.64 T
BL product	BXL	6.5 T·M	11 T·M	6.7 T·M	11 T·M
Electrical Data					
Nominal Impedance	Z	2.0 ohm	4.0 ohm	2.0 ohm	4.0 ohm
DC Resistance	RE	1.3 ohm	3.0 ohm	1.3 ohm	3.0 ohm
Voice Coil Inductance @ 1KHz	LBM	0.38 mH	1.1 mH	0.37 mH	1.1 mH
T-S Parameters					
Suspension Compliance	CMS	0.34 $\frac{m}{N}$	0.3 $\frac{m}{N}$	0.29 $\frac{m}{N}$	0.3 $\frac{m}{N}$
Mechanical Q Factor	QMS	4.46	4.58	6.18	5.8
Electrical Q Factor	QES	0.55	0.51	0.63	0.52
Total Q Factor	QTS	0.49	0.46	0.57	0.47
Mechanical Resistance	RMS	3.85 $\frac{N}{m}$	4.22 $\frac{N}{m}$	3.42 $\frac{N}{m}$	3.7 $\frac{N}{m}$
Moving Mass	MMS	102g	111.4g	127.8g	135.8g
Resonant Frequency	FS	27 Hz	27 Hz	26 Hz	26 Hz
Eq. Cas Air Load (liters)	VAS	63.4 Lit (2.24cu.ft)	54.6 Lit(1.93 cu.ft)	88.8 Lit(3.13cu.ft)	92.2 Lit(3.25cu.ft)
Effective Piston Area	SD	0.0346 m ²	0.0346 m ²	0.0471 m ²	0.0471 m ²

Overall Dimensions

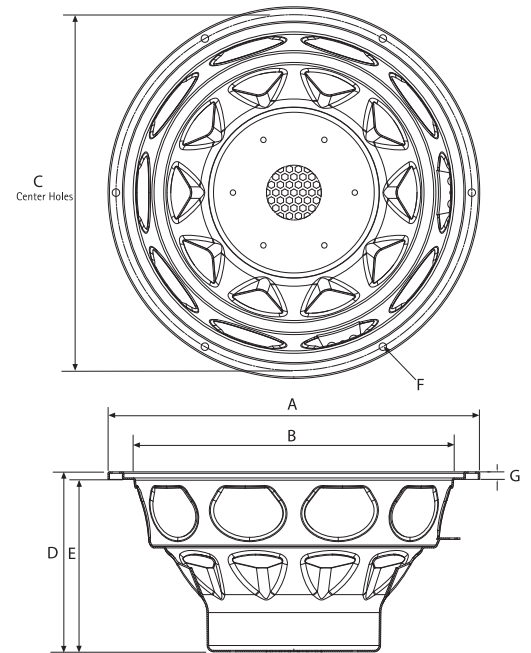

	ULTIMO TITANIUM SC 10	ULTIMO TITANIUM SC 12
A	∅10.35" (263mm)	∅12" (305mm)
B	∅ 8.87" (225.15mm)	∅10.35" (263mm)
C	∅9.96" (253mm)	∅ 11.5" (292mm)
D	5.63" (143mm)	5.96" (151.5mm)
E	5.38" (136.6mm)	5.72" (145.3mm)
F	∅0.244" (6.2mm)	∅0.255" (6.5mm)
G	∅0.267" (6.8mm)	∅0.255" (6.5mm)

UNLEASH THE MUSIC



More Ltd.
Tel: +972-8-9301161
Fax: +972-8-9301312
E-mail: info@more.co.il
www.morehifi.com

More America
Tel: 1-877-more -11
Fax: 1-718-721-1560
E-mail: info@moreamerica.com

Warning

We care about your hearing!!! More's Ultimo series is capable of producing sound levels that can permanently damage your hearing! Turning up a system to a level that has audible distortion is more damaging to your ears than listening to an undistorted system at the same volume level. Please use common sense and precaution when using your sound system.