



# Installation Manual Double DIN Kit

Part No.: CT23FD28

## Ford Focus 2011 >

Compatible with these double DIN devices

### Double DIN Navigation

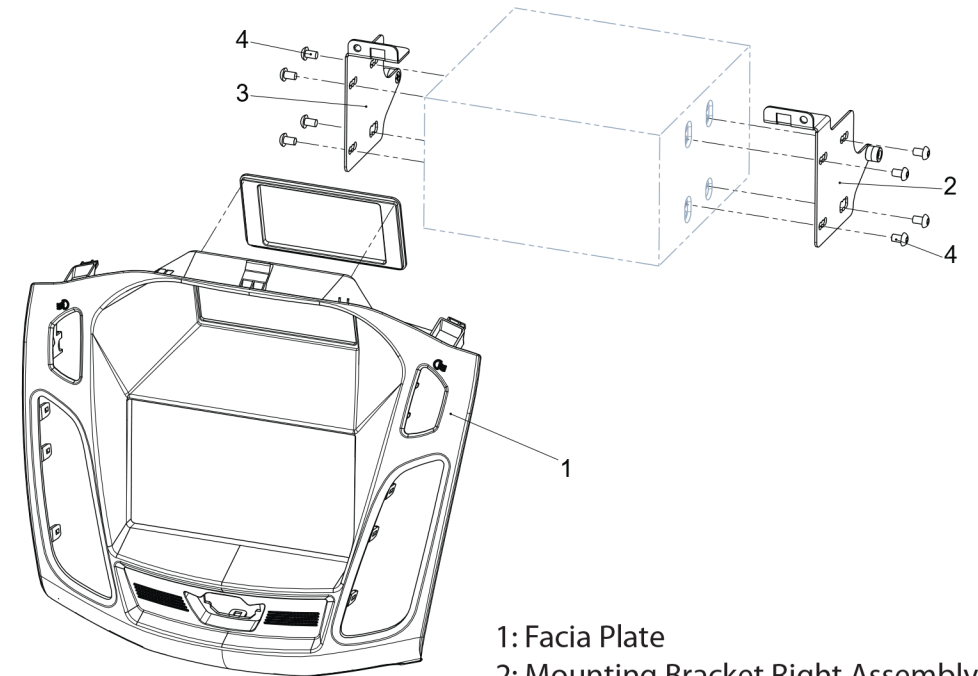

Spare OEM hazard light  
switch by Ford required (1690881)



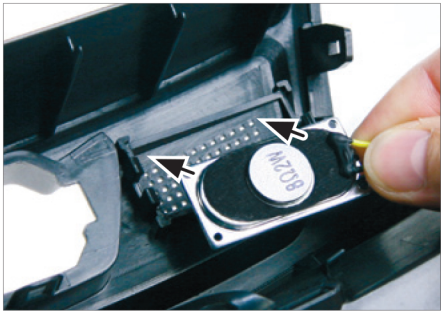

14. as needed fix speaker with cyanoacrylate adhesive



15. A spare OEM hazard light switch by Ford is required.



16. Mount spare hazard light switch to facia plate. Clip facia plate on dash board. Install everything in reverse order.

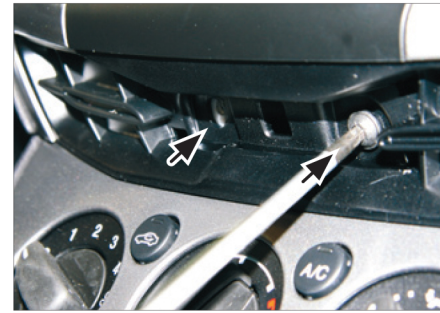

4a. Remove 2 screws under OEM radio



5. Unclip OEM panel



6. Remove OEM panel carefully

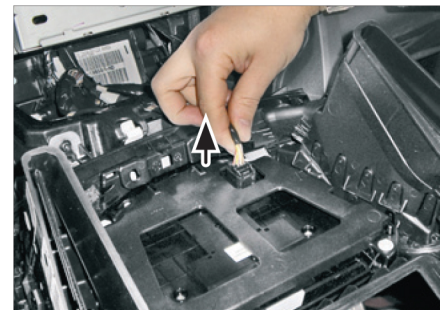

7. Unplug cables



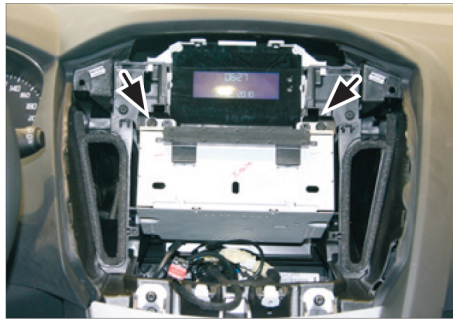

8. Remove 2 screws ( see arrows)  
Remove OEM head unit



9. OEM dash board with removed head unit

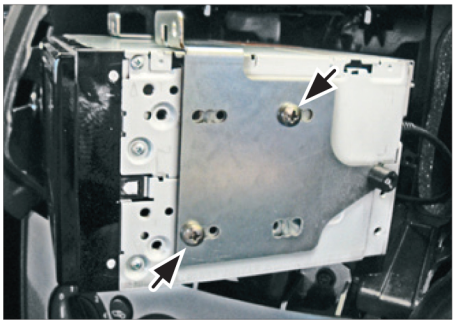

10. Mount mounting brackets to double DIN head unit



11. Install double DIN head unit  
Connect all required circuit points and connections. Please see stalk interface manual for connecting stalk interface  
Fix navigation with OEM screws

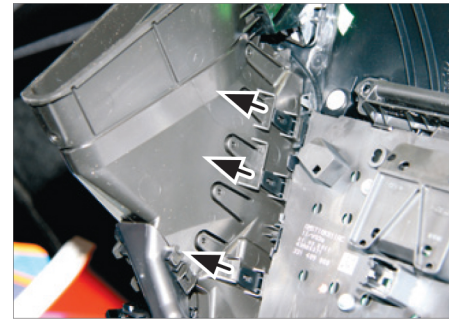

**Preperation of fascia plate**

12. Unclip 2 OEM air vents

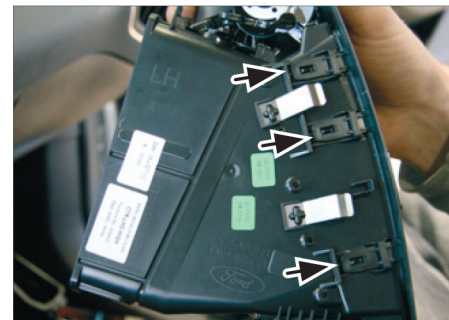

**Preperation of fascia plate**

13. Mount them to new fascia plate



The Focus is equipped with two kinds of OEM displays

**A: Display with 2 buttons at right side (see arrow)**

No trim frame required



**B: Colour Display:**

Clip trim frame to fascia plate

